



\* All images are for illustrative purposes only.

**Commercial TV** US660H (ASIA)

# LG Smart Hotel TV with Effective Content Management

The US660H series supports clear Ultra HD and efficient content management with Pro:Centric solutions. In addition, the new webOS 5.0 for a wide variety of customer needs, provides customized content in an easier way.



Pro:Centric Hotel Management Solution



Voice Recognition



Quick Menu

# Pro:Centric HOTEL MANAGEMENT SOLUTION

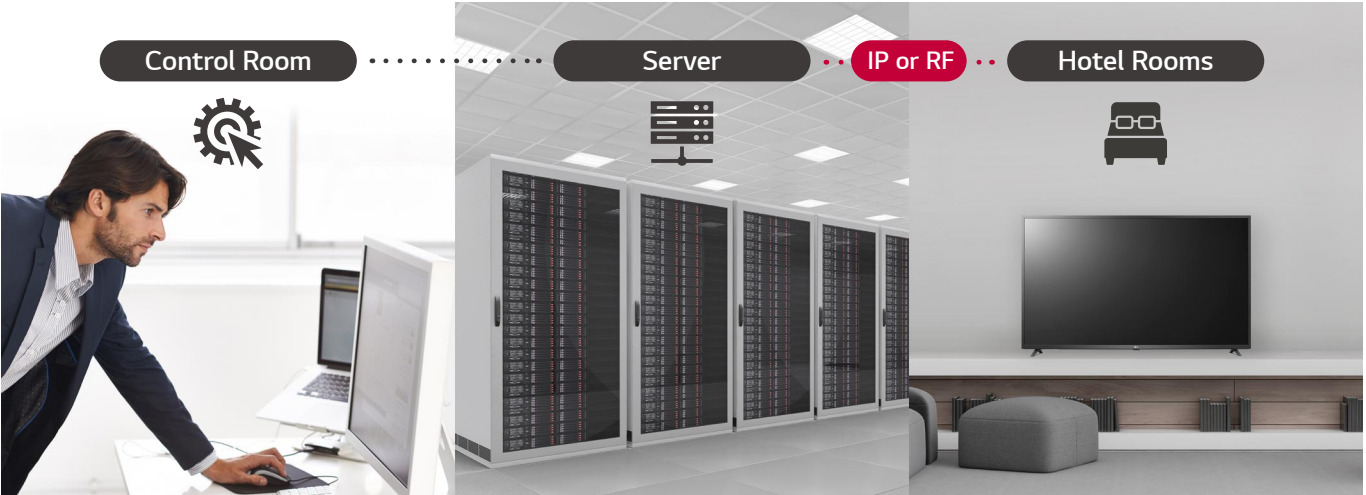

## Pro:Centric Direct

The hotel content management solution Pro:Centric Direct offers easy and simple editing tools, making it easy to perform service and IP network-based remote management with a single click. The Pro:Centric Direct solution enables users to edit their interface easily by providing customized interface and efficiently manages all TVs in the room. The latest PCD version provides IoT-based in-room control as well as voice control function through LG Natural Language Processing (NLP). These IoT and voice-related functions will be your starting point to prepare for the hotel rooms of next generation through artificial intelligence.

\* Some features may not be supported based on PCD versions.

## VALUE ADDED FEATURES

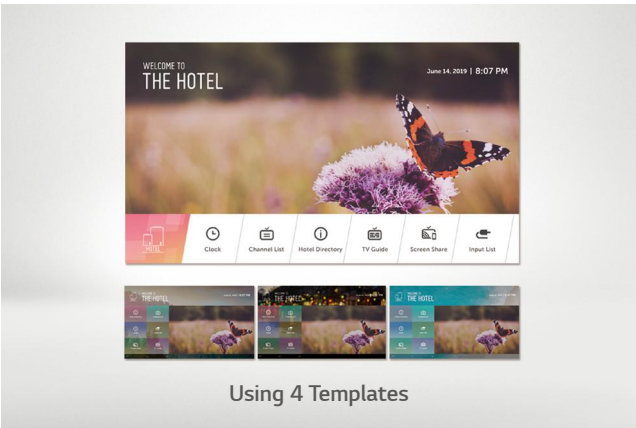

Using 4 Templates

## Quick Menu

Now LG provides the new Quick menu (ver. 4.0), making it easier and more user-friendly than ever. The home menu solution has been upgraded in a big way with the addition of the new Hotel Promotional Video Creation Tool. Users can now also use Quick Manager for easy information distribution throughout the same network without a server or USB Cloning function, making this the perfect solution for Stand-Alone Usage Scenes.



## More Innovative LG webOS 5.0

Explore the latest LG Smart TV features, and discover TVs that deliver innovative technology, remarkable clarity, and true-to-life colors. Newly added Mood Display & Gallery Mode enable you to utilize the TV as a customized clock and an artwork which perfectly harmonizes with your space and life.

# VALUE ADDED FEATURES

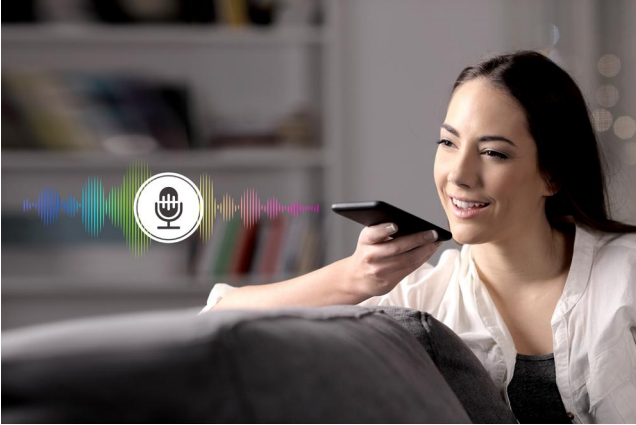

## Voice Recognition

From seamless interaction to consistent user experience, LG is going one step further to lead the commercial TV market by including voice recognition, allowing users to easily control LG TVs. Our stable and dependable solutions based on webOS and Pro:Centric Direct will significantly enhance the competitiveness of our products and services, helping you achieve a successful business in the future.

- \* TV native Control
- \* Server Based Control
- \* Magic Motion Remote is required (sold separately)

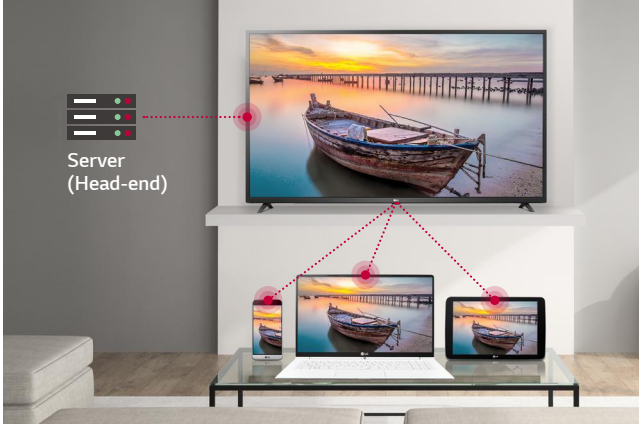

## Soft AP

Software-enabled Access Point (Soft AP) is a "virtual" Wi-Fi feature that uses software to create a wireless hotspot. The current version supports Bridge Mode, which enables network administrators to manage connected devices and collect useful information such as signal level, Soft AP passwords, etc.

- \* SoftAP should be set in the installation menu after the TV is turned on.
- \* Smart Mirroring may not be operated at the same time.

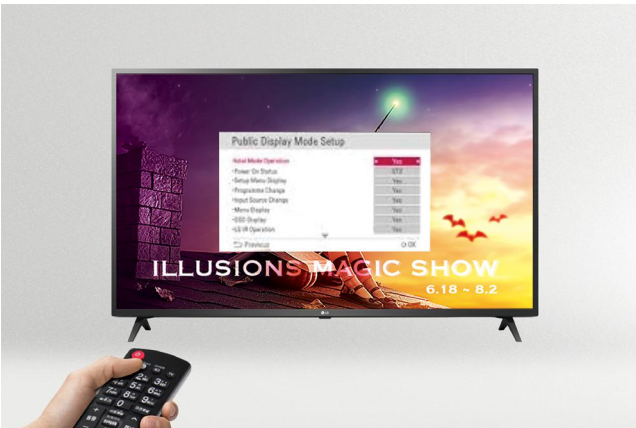

## Hotel Mode (Public Display Mode)

From channel selection to volume level, you can control the TV settings in business areas. Public Display Mode also enables you to restore default settings, as required, on the TVs.



## Welcome Video / Screen

With the capability to display several images, Commercial Lite TVs allow for a greater variation of greeting messages in hotel rooms which make customers feel more welcome and cared for.

## VALUE ADDED FEATURES



### USB Cloning

USB data cloning makes managing multiple displays more efficient for optimal operation. Instead of setting up each display one by one, data can be copied to a USB for one display and can be sent to the other displays through a USB plug-in.



### Remote Diagnostics

Save big expenses with the management of commercial TV with Remote Diagnostics. Real-time Remote Diagnostics reports and detects error early in advance to prevent TVs from malfunctioning.



### IR Out

Using the interactive set-top box, all LG TVs can be controlled with a single remote control.



### External Speaker Out

Enhance the entertainment experience with an additional speaker. Guests can listen and control the TV audio from anywhere, even from restrooms.

# PRODUCT INFORMATION



## US660H (ASIA)

Design	Stand Type	2 Pole Stand
	Front Color	Ceramic Black
Display	Inch	65" / 55" / 50" / 43"
	Resolution	3,840 × 2,160 (UHD)
Solution	Pro:Centric (Smart, Direct, V), Quick Menu	

## DIMENSION

(unit: mm)

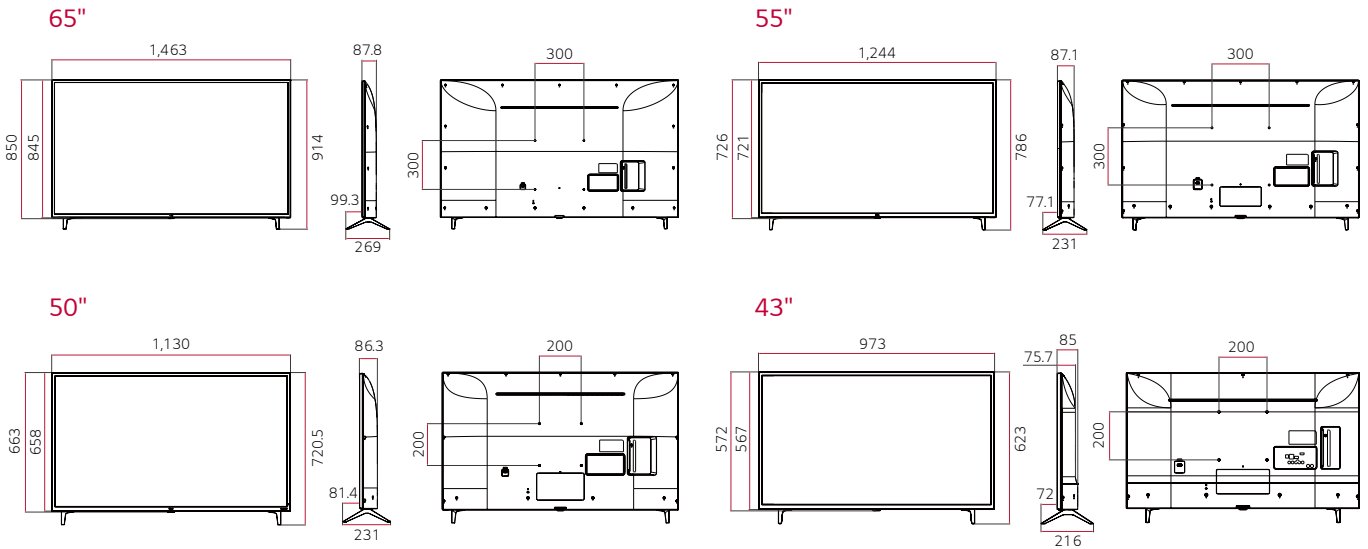

## CONNECTIVITY

65" / 55" / 50" / 43"

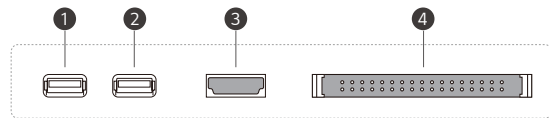
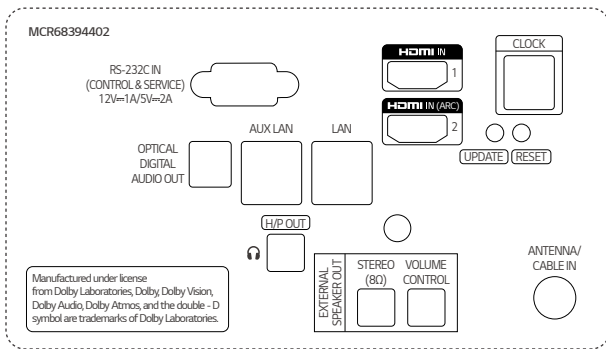

- 1 USB IN 1
- 2 USB IN 2
- 3 HDMI IN
- 4 PCMCIA CARD SLOT

\* Dimensions & Jack Panels may differ from the above image, so please contact the LG sales team to verify before ordering.



Download  
LG C-Display+  
Mobile App  
Google Play Store

www.lg.com/global/business/information-display  
www.youtube.com/c/LGCommercialDisplay  
www.facebook.com/LGInformationDisplay  
www.linkedin.com/company/lginformationdisplay  
twitter.com/LG\_ID\_HQ

LG may make changes to specifications and product descriptions without notice. Copyright © 2020 LG Electronics Inc. All rights reserved. "LG Life's Good" is a registered trademark of LG Corp. The names of products and brands mentioned here may be the trademarks of their respective owners.

