



A standard Smart Hotel TV with Pro:Centric Smart

Enhance in-room experience and hotel brand image with the interactive smart solution, Pro:Centric SMART. The LT660H includes SDK Tools, Pre-loaded Apps, and hospitality content management software, Pro:Centric SMART/Direct/V, which can be customized by users. Also, its smart connecting functions including SmartShare, SmartScreen, Bluetooth Sound Sync enhance guests' in-room entertainment and convenience.

-  Pro:Centric Hotel TV Management Solution
-  Voice Recognition
-  Quick Menu



* Actual product appearance may differ from the image above.



Pro:Centric Hotel Management Solution

Pro:Centric SMART is optimized for customizing hospitality services for hotel brands and guests through an IP & RF infrastructure. With its high picture quality, sophisticated design, and advanced connectivity functions, it upscales in-room entertainment and enhances convenience through high-end technology.

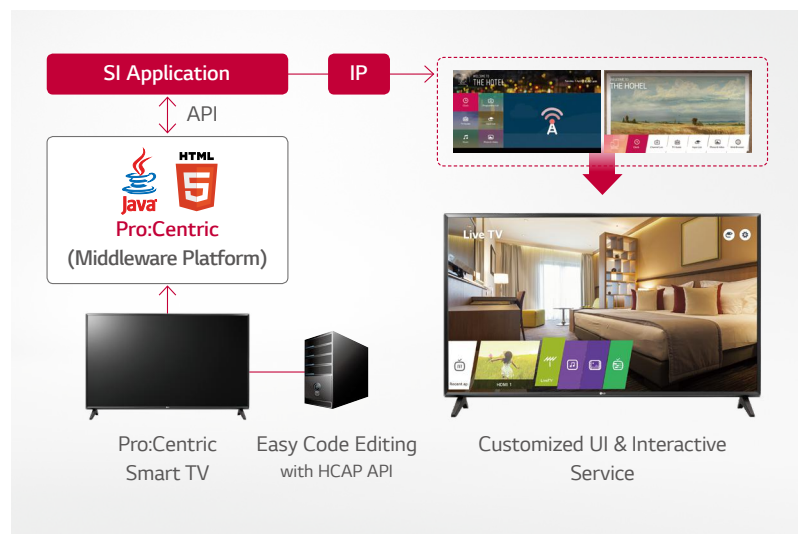

* Customized UI may be little different.

Pro:Centric Server Application

You can now express your hotel's unique identity with our customizable templates and pages. Pro:Centric provides you with a solution that be especially customized for your business.

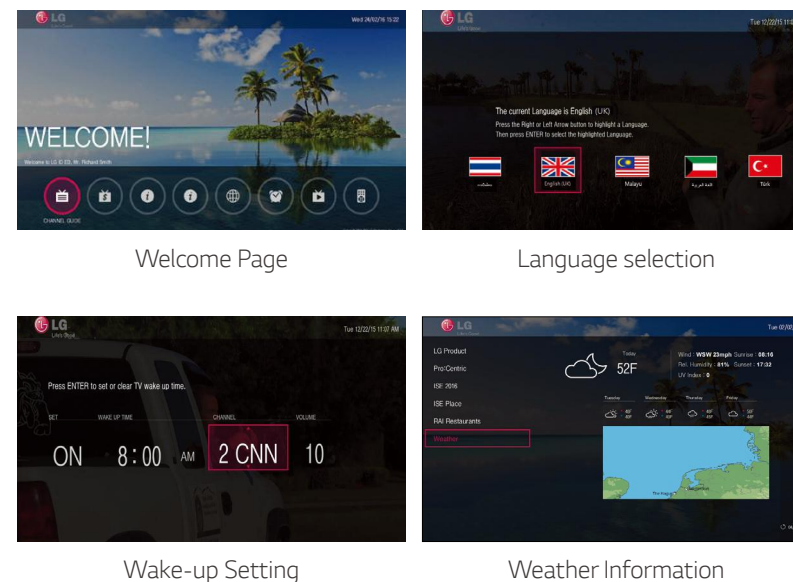

Pro:Centric Direct Solution

Pro:Centric Direct is a hotel content management system that supports simple editing tools and provides various solutions such as 1-click service and IP network-based remote management. With this solution, users can easily edit the user interface, provide customized service, and efficiently manage all TVs.

PCD version 3.0 offers IoT-based In-room control, as well as voice control through LG Embedded Natural Language Processing (NLP). These IoT and voice-related features will prepare hotels for a future where rooms will be enhanced by artificial intelligence.

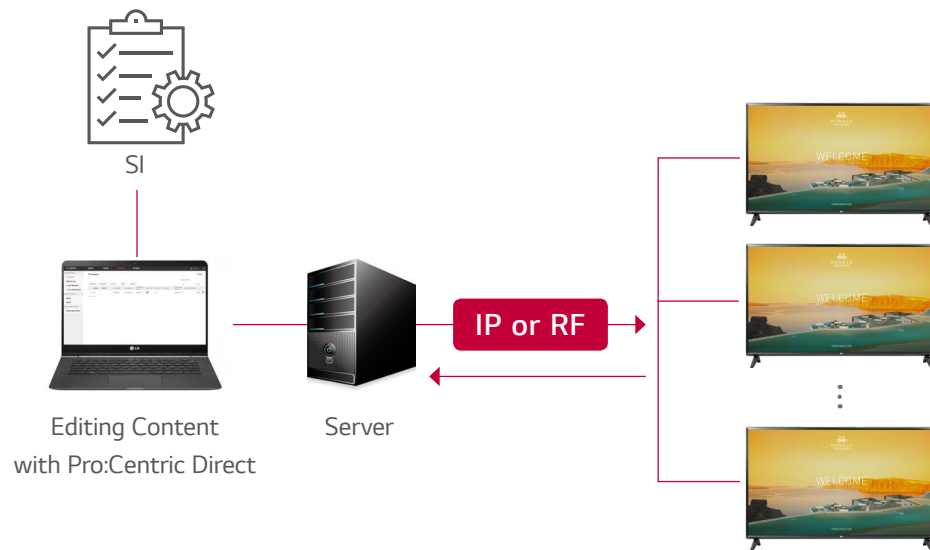

* Actual UI may slightly differ when implemented.

* When PCS400R and PCD 2.0 are used, PCD feature is available, even in RF infrastructure. However, to provide interactive services in an RF infrastructure, Wi-Fi is required (RF+Wireless Infrastructure).

Smart TV by LG webOS 4.5

This is LG Smart TV with webOS 4.5. Explore the latest LG Smart TV features, and discover TVs that deliver innovative technology, remarkable clarity, and true-to-life colors.



* Actual In-screen image may slightly differ.

Voice Recognition

From seamless interaction to consistent user experience, LG is going one step further to lead the commercial TV market by including voice recognition, allowing users to easily control LG TVs. Our stable and dependable solutions based on webOS and Pro:Centric Direct will significantly enhance the competitiveness of your products and services, helping you achieve a successful future for your business.



- * TV native Control
- * Server Based control
- * Magic Motion Remote is required (sold separately)

Soft AP

Software-enabled Access Point (SoftAP) is a "virtual" Wi-Fi feature that uses software to create a wireless hotspot. The current version supports Bridge Mode, which enables network managers to control connected devices.



* SoftAP should be set in installation menu after TV is on.
* Smart Mirroring may not be operated at the same time.

Instant On

The high speed loading system enables users to enjoy content immediately after turning on the TV.



* Actual remote control may slightly differ.

SmartShare

SmartShare allows users to share content more quickly. It also searches for the content they want in order to share it more easily, thereby simplifying the process of sharing between various devices.



ScreenShare

Connect a smartphone or a laptop PC to TV via a Wi-Fi Direct connection. The TV will display the device's screen, and users can share their content and memories together.



Bluetooth Sound Sync

Bluetooth Sound Sync enables users to listen to music on a mobile device through TV speakers via Bluetooth connection.



* Support devices for Bluetooth Sound Sync: Android (above v4.4 KitKat) / iOS based mobile device

Quick Menu

Enjoy LG's easy home menu solution. Now LG provides the new Quick menu (ver. 3.0), making it easier and more user-friendly than ever. The solution has been upgraded in a big way with the addition of the new Hotel Promotional Video Creation Tool. Users can now also use Quick Manager for easy information distribution throughout the same network without a server or USB Cloning function, turning the solution into a perfect solution for Stand Alone Usage Scenes.

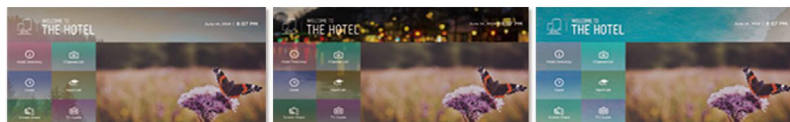
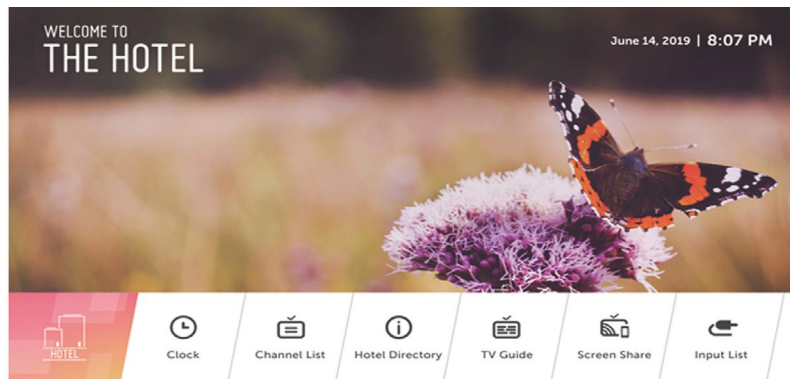

4 Templates

Hotel Mode

From channel selection to energy-saving features, you can control the TV settings in all the rooms from the center with Hotel Mode. Prevent misuse by customers, set volume limits, or reset to default settings for any TV. You are in control of it all.

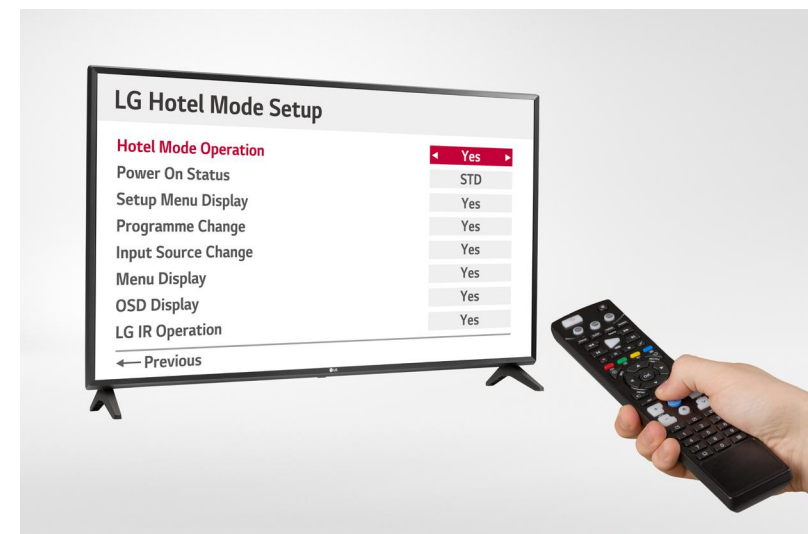

* Actual remote control may slightly differ.

Welcome Video / Screen

With the capability to display repeatedly various video formats as well as images, Commercial Lite TVs allow for a greater variation of greeting messages in hotel rooms which make customers feel more welcome and cared for.



EzManager

EzManager provides a convenient installation function for automatically set up Pro: Centric TV settings without the extra effort of configuration. Auto-installation requires 1-3 minutes while manual installation requires 3-5 minutes.

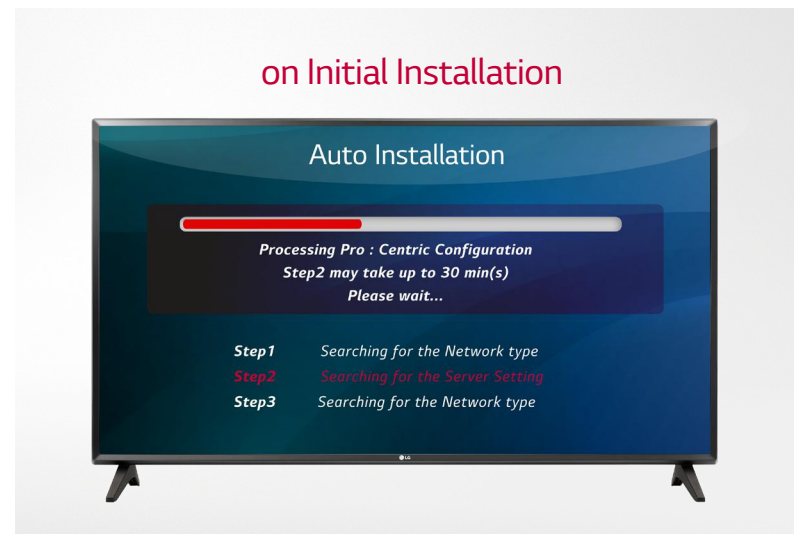

USB cloning

USB data cloning makes managing multiple displays more efficient for optimal operation. Instead of setting up each display one by one, data can be copied to a USB for one display, and then that data will be sent to the other displays through a USB plug-in.

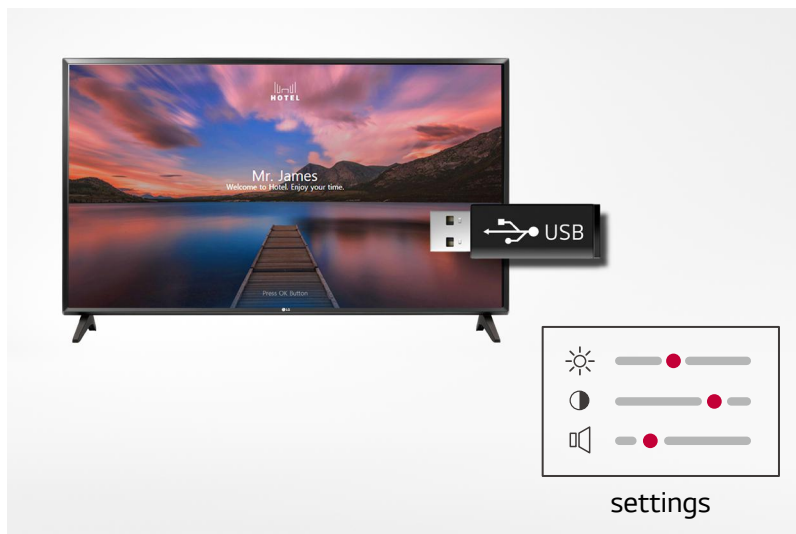

Pro:Idiom

Prevent any illegal copying of content with widely used DRM (Digital Right Management).



32"

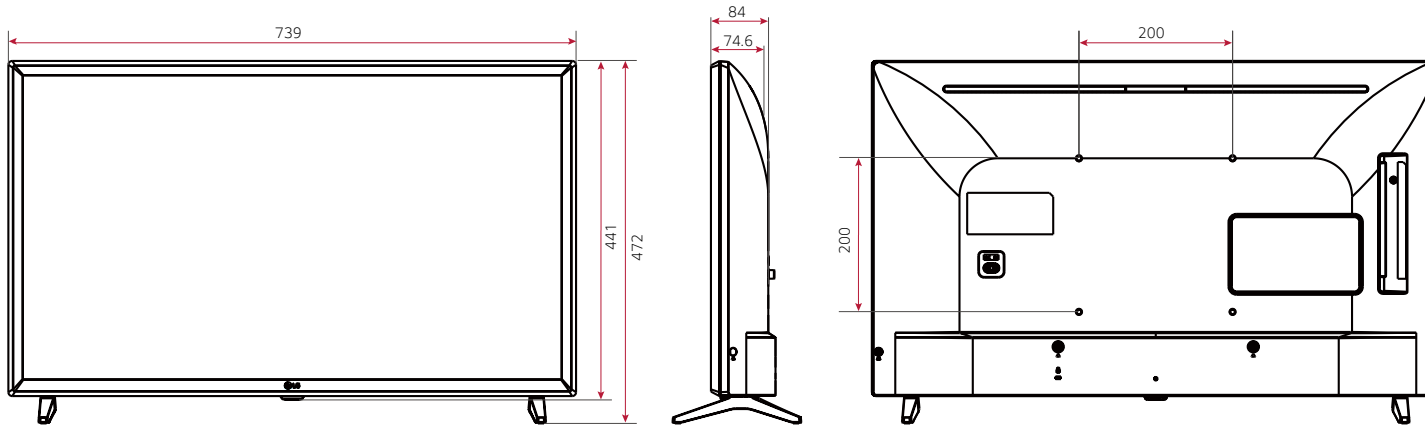

CONNECTIVITY

32"

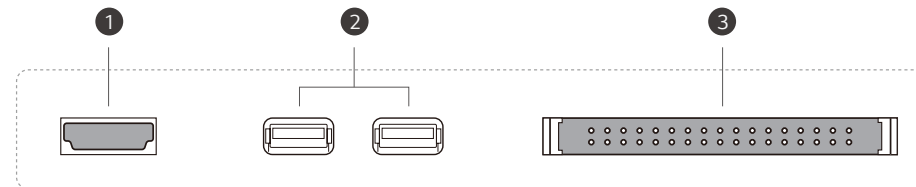
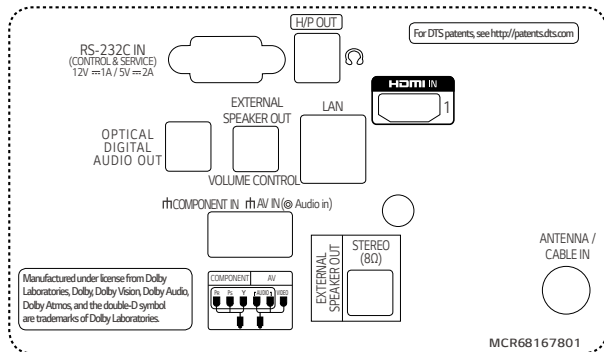

- 1 HDMI IN
- 2 USB IN
- 3 PCMCIA CARD SLOT

* Dimensions & Jack Panels (Read/Side) may differ from the above image, so please contact LG sales team to verify before ordering.

SPECIFICATION

Hotel TV | **LT660H**

LT660H (Asia)		32LT660H (Asia)
DESIGN	Stand Type	2 Pole
	Front Color	Ceramic Black
DISPLAY	Inch	32
	Resolution	1,366 x 768 (HD)
	Backlight Unit Type	Direct
	Brightness	240nit
BROADCASTING SYSTEM	Digital	DVB-T2 / C
VIDEO	HDR (10 Pro / HLG)	No / No
AUDIO	Audio Output	5W + 5W
	Speaker System	2.0 ch
	DOLBY ATMOS	No
	One Touch Sound Tuning	Ready
	LG Sound Sync	Bluetooth required
HOSPITALITY SOLUTION	Solution Type	Pro:Centric (Smart, V, Direct), Quick Menu 3.0
	Data Streaming (IP & RF)	Yes
	HCAP (GEM / FLASH / HTML) ※ Service Carousel (TLL / XML)	GEM / HTML5
	IP Return path	Yes
	Multicast / Unicast ready	Yes
	webRTC (Real Time Communication)	Yes
	Pro:Centric Application (version)	PCA3.8
	Pro:Centric Server	PCS400R
DRM	Pro:Idiom (S/W Type), Pro:Idiom Media	
SMART FEATURE	webOS 4.5, Smart Home (Launcher Bar), Quick Access, Web Browser, Pre-loaded App, SDP Server compatibility, Magic Remote Compatibility (Ready)(TBD), Clock (World Clock / Alarm), Soft AP, Wi-Fi (802.11ac, Built-in type), Screen Share (Miracast), Smart Share (DLNA), LG TV Plus App Compatibility, DIAL, Bluetooth Audio Playback, LG Sound Sync / Bluetooth, Mobile Connection Overlay, Voice Recognition (Standalone / Solution), IoT, EzManager (Simplicity), USB Cloning, Wake on RF, Wake on LAN, SNMP, Diagnostics (IP Remote), SI Compatible (TVLink Interactive), HTNG-CEC (1.4), Simplink (HDMI-CEC, 1.4), IR Out (RS-232C, HDMI), Multi IR Code, Anti-theft System (Kensington Lock), Chromecast Dongle Anti-theft Cover (Optional)	
HOSPITALITY FEATURE	Hotel Mode (Installer Menu), Lock mode (Limited), Welcome Video / Screen (Splash Image), Insert Image, One Channel Map, IP Channel Manager, External Speaker Out (Int / Ext Variable / Fixed), Instant ON, RJP (Remote Jack Pack) Compatibility, Moving Picture Playback (SD / HD / Plus HD), Auto Off / Sleep Timer, Smart Energy Saving, Motion Eye Care	
JACK INTERFACE	Set Side	HDMI In 2.0, USB 2.0 (2), CI Slot
	Set Rear	HDMI In (HDCP 2.0), Headphone Out, RF In (1), AV In (Phone Jack Type), Component in (Y,Pb, Pr-Video, Phone Jack Type), Digital Audio Out (Optical), RS-232C (Control & Service), RJ45 (Usage Purpose : 1 (Ethernet)), External Speaker Out (3.5mm Phone Jack) : 2 (Spk-out 1, 4W (Stereo, R : 2.0W, L : 2.0W, 8Ω) - Vol. Control1)
DIMENSION (UNIT : mm / kg)	Vesa	200 x 200
	W x H x D / Weight (with stand)	739 x 472 x 168 / 4.90
	W x H x D / Weight (without stand)	739 x 441 x 84 / 4.85
	W x H x D / Weight (Shipping)	812 x 510 x 142 / 6.10
POWER (UNIT : WATTS)	Power Supply (Voltage, Hz)	100 - 240V, 50/60Hz
	Typical	46.3W
	Stand-by	0.5W

* Specifications are subject to change without notice, so please contact LG sales team to verify before ordering.



www.lg.com/b2b
www.youtube.com/c/LGCommercialDisplay
www.facebook.com/LGInformationDisplay
www.linkedin.com/company/LGInformationDisplay

LG may make changes to specifications and product descriptions without notice.
 Copyright © 2019 LG Electronics Inc. All rights reserved. "LG Life's Good" is a registered trademark of LG Corp.
 The names of products and brands mentioned here may be the trademarks of their respective owners.

